

RESOLUTION NO. 22-19

TO THE OFFICE OF ADMINISTRATIVE HEARINGS  
A JOINT RESOLUTION  
OF THE CITY OF STEWARTVILLE AND THE TOWNSHIP OF HIGH FOREST  
DESIGNATING AN UNINCORPORATED AREA AS IN NEED ORDERLY  
ANNEXATION AND CONFERRING JURISDICTION OVER  
SAID AREA UPON THE OFFICE OF ADMINISTRATIVE HEARINGS PURSUANT  
TO MINN. STAT. §414.0325  
AND THE TERMS OF THIS AGREEMENT.

Whereas, the City of Stewartville and the Township of High Forest desire to accommodate growth in the most orderly fashion; and

Whereas, a joint orderly annexation agreement between the parties hereto is beneficial to both parties from the standpoint of orderly planning and orderly transition of government within the area proposed to be annexed, and provides the guidelines under which such annexation shall take place; and

Whereas, the Parties hereto desire to enter into a binding contract which encompasses the terms of this Joint Resolution;

NOW THEREFORE BE IT RESOLVED by the City of Stewartville (hereinafter referred to as "the City") and the Township of High Forest (hereinafter referred to as "the Township") that the property described herein is designated for orderly annexation by the City and shall be annexed subject to the following conditions:

- I. The property which is covered by this orderly agreement is legally described as follows:

See Exhibits "A" and "B" attached hereto and made a part hereof by reference.

- II. The City and the Township hereby agree that the property described in Exhibit "A" shall be immediately annexed to the City.

- III. Any General Development Plan presented to the City involving the property described in Exhibits "A" or "B" shall be provided to the Township within fourteen (14) days of the City's receipt of the General Development Plan.

- IV. The parties agree that the property described in Exhibit "B" shall not be annexed to the City during the term of this Agreement unless the owner petitions for annexation and unless the parcel or parcels share a common boundary with the City at not less than one point.

- V. The City may annex parcels of land contained within the property described in the attached Exhibit "B" if all the owners of said parcels of land request annexation and if said parcel or parcels share a common boundary with the City at not less than one point, except as provided in Section VI. The procedures set forth in Sections XV and XVI shall be followed if the City annexes property included within Exhibit "B".
- VI. No part of the property described in Exhibit "B" may be annexed to the City unless the landowners owning the land in the area to be annexed request annexation. All land to be annexed shall be reasonably compact in size and, after annexation, should not isolate other parcels of land. Notwithstanding any other provisions of the Agreement, however, nothing herein shall prevent the City from annexing any property pursuant to Minn. Stat. §414.033, Subd. 2(2), which specifically allows the annexation by ordinance of land that is completely surrounded by land within the municipal limits. In addition, nothing herein shall prevent the City from annexing property owned by the State of Minnesota, United States of America, pursuant to Minn. Stat. §414.033. In addition, any parcels of land that are located within the Township that are owned by the City on or before the date of this agreement may be annexed to the City pursuant to Minn. Stat. §414.033. Nothing herein shall prevent the City from annexing any property pursuant to Minn. Stat. §414.033, Subd. 3.
- VII. Office of Administrative Hearings. That upon approval by the parties, this Agreement shall confer jurisdiction upon Office of Administrative Hearings so as to accomplish said orderly annexation in accordance with the terms of this Agreement.  
Review and Comment by Office of Administrative Hearings. The City and Township mutually state that this Agreement sets forth all of the conditions for annexation of the area designated herein for orderly annexation to Stewartville and that no consideration by Office of Administrative Hearings is necessary. Office of Administrative Hearings may review and comment, but shall, within thirty (30) days, order annexation in accordance with the terms and conditions of this Agreement.
- VIII. All annexations within the property shall be consistent with the City's policies concerning the extension of municipal utilities.
- IX. The City must construct and provide water, sanitary sewer, storm sewer and street improvements to the property as requested by the owner, pursuant to state and local law, at the discretion of the City and based on the policies of the City then in effect.

- X. For each annexation that occurs under this Agreement, the electric utility service notice as required by Minn. Stat. §414.0325, Subd. 1a. must be satisfied.
- XI. The parties agree to the following division of tax revenues and payment of special assessments for local improvements to the property:

- A. Property Taxes: Property taxes payable on the annexed land shall continue to be paid to the Township for the year in which the annexation becomes effective. Thereafter, property taxes on the annexed land shall be paid to the City. However, the City shall make cash payment to the Township according to the following schedule:

- Year 1 through Year 5 – 100% of property taxes paid in year annexed

- Year 6 – 90% of property taxes paid in year annexed

- Year 7 – 70% of property taxes paid in year annexed

- Year 8 – 50% of property taxes paid in year annexed

- Year 9 – 30% of property taxes paid in year annexed

- Year 10 – 10% of property taxes paid in year annexed

- Any tax payment due to the Township pursuant to this section shall be paid within thirty (30) days of receipt by the City of the tax distribution form Olmsted County.

- B. Utility and Street Assessments: When properties are located outside the corporate City limits of the City and City sewer, water and street improvements benefit the property, the property owner shall be charged Development Charges and special Connection Charges equal to the cost of the improvements plus interest at a rate equal to the interest rate on the City's bonded indebtedness for the project. If and when the City pays the bonded indebtedness on the project in full, no further interest shall be charged. The Development Charges shall be payable when the property has been annexed to the City and a final plat for the development of any portion of the owner's property is approved.

- C. The City guarantees payment in full pursuant to the above formula within a maximum of 6 years from the date hereof. The City shall have the right to prepay its obligation set forth in paragraph A above at any time.

- XII. The Township and the City shall enter into agreements providing the equitable division of the costs and responsibilities to be borne by each for the maintenance of roads adjoined by both parties. In the event that an equitable agreement cannot be reached, either the Township or the City may petition the County to

resolve the matter as per Minn. Stat. §164.14, Subd. 4. When deemed necessary, the services of the County Engineer may be used.

- XIII. This Agreement will go into effect on the date that the Orderly Annexation Agreement is approved by the Office of Administrative Hearings. Each subsequent annexation within the Property designated by this Agreement must be submitted to the Office of Administrative Hearings.
- XIV. This Agreement shall expire five years from its effective date, subject to an automatic extension for an additional five years upon written 60-day notice by either party, and provided that nothing herein shall prevent the City and the Township from amending this Agreement during its term.
- XV. If the City intends to annex a parcel of property included in Exhibit "B," the City shall submit to the Township the following:
  - A. The legal description of the property to be annexed and a map of the property to be annexed.
  - B. Description of the proposed use of said property.
  - C. A General Development Plan for the parcel to be annexed.
- XVI. If the property owner petitions for the annexation of a parcel of land described in paragraph XV above, the City and the Township shall do the following:
  - A. Within ten (10) days of the receipt by the City of a Petition for Annexation, the City shall forward a copy of the same to the Township.
  - B. The City shall schedule a Public Hearing and notify all contiguous property owners and the Township of said Public Hearing.
  - C. Within forty (40) days of the receipt by the Township of the Petition for Annexation, the Township shall provide its written comments, if any, to the City.
  - D. If the City adopts a Resolution approving the annexation, the City shall provide a copy of said Resolution to the Township within five (5) business days.
- XVII. This Resolution shall be a binding contract upon the parties herein, and may be enforced in either Law or Equity, notwithstanding future amendments in Minnesota Statutes, except as specifically provided otherwise in this Agreement.

Approved by the Township of High Forest, this 1st day of November, 2022.

TOWNSHIP OF HIGH FOREST

  
\_\_\_\_\_  
Township Board Chair

  
\_\_\_\_\_  
Township Board Clerk

Approved by the City of Stewartville, this 26 day of October, 2022.

CITY OF STEWARTVILLE

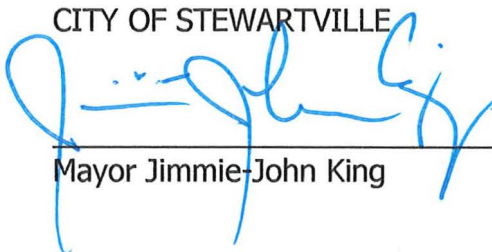
  
\_\_\_\_\_  
Mayor Jimmie John King

ATTEST:

  
\_\_\_\_\_  
William Schimmel, Jr.  
City Administrator

## EXHIBIT A: 10<sup>TH</sup> STREET N.W.

(Formerly C.S.A.H. No. 35)

The South 50 feet of the Southwest Quarter of the Southwest Quarter of Section 27, Township 105 North, Range 14 West, Olmsted County, Minnesota.

AND

The South 50 feet of the Southeast Quarter of the Southeast Quarter of Section 28, Township 105 North, Range 14 West, Olmsted County, Minnesota.

AND

The South 50 feet of the following described parcel located in the Southeast Quarter of Section 28, Township 105 North, Range 14 West, Olmsted County, Minnesota, except land already within the City:

Commencing at the southwest corner of the Southeast Quarter of Section 28, Township 105 North, Range 14 West; thence East along the south line of said Southeast Quarter a distance of 456.00 feet; thence deflect left 89 degrees 07 minutes a distance of 1049.00 feet; thence deflect left 90 degrees 53 minutes a distance of 475.00 feet to the west line of said Southeast Quarter; thence deflect 90 degrees 09 minutes 40 seconds along said west line a distance of 1048.82 feet to the point of beginning.

AND

The South 50 feet of the Southwest Quarter of Section 28, Township 105 North, Range 14 West, Olmsted County, Minnesota.

AND

That part of Tract A described below:

### Tract A

The East Half of the Southeast Quarter of Section 29, Township 105 North, Range 14 West, Olmsted County, Minnesota;

which lies southeasterly of a line run parallel with and distant 100 feet southeasterly of Line 1 described below and southerly of Line 2 described below:

### Line 1

Beginning at a point on the south line of said Section 29, distant 1552.8 feet east of the south quarter corner thereof; thence run northeasterly at an angle of 52 degrees 10 minutes 00 seconds with said south section line (measured from east to northeast) for 600 feet and there terminating;

### Line 2

Beginning at a point on said 100 foot parallel line, distant 80 feet northeasterly of its intersection with a line run parallel with and distant 33 feet north of the south line of said Section 29; thence run southeasterly to a point on said 33 foot parallel line, distant 550 feet easterly of said intersection and there terminating.

AND

## EXHIBIT A: 10<sup>TH</sup> STREET N.W.

(Formerly C.S.A.H. No. 35)

That part of the South 50 feet of the East Half of the Southeast Quarter of the Southeast Quarter of Section 29, Township 105 North, Range 14 West, Olmsted County, Minnesota, lying northeasterly and easterly of the following described line:

Beginning at a point on said 100 foot parallel line, distant 80 feet northeasterly of its intersection with a line run parallel with and distant 33 feet north of the south line of said Section 29; thence run southeasterly to a point on said 33 foot parallel line, distant 550 feet easterly of said intersection; thence South at a right angle to the south line of said Southeast Quarter 33.00 feet and said line there terminating.

AND

That part of Tract A described below:

### Tract A

The Northeast Quarter of the Northeast Quarter of Section 32, Township 105 North, Range 14 West, Olmsted County, Minnesota;

which lies between two lines run parallel with and distant 100 feet and 166 feet southeasterly of Line 1 described below:

### Line 1

Beginning at a point on the north line of said Section 32, distant 1552.8 feet east of the north quarter corner thereof; thence run southwesterly at an angle of 52 degrees 10 minutes 00 seconds with said north section line (measured from west to south) for 600 feet and there terminating;

together with that part of Tract A hereinbefore described, which lies southeasterly of the above described strip and westerly and northerly of the following described line: Beginning at a point on a line run parallel with and distant 33 feet south of the north line of said Section 32, distant 375 feet easterly of its intersection with the southeasterly boundary of the above described strip; thence run southerly at right angles with said 33 foot parallel line for 82 feet; thence run westerly to a point on said southeasterly boundary, distant 160 feet southwesterly of said intersection.

### **EXCEPT:**

That part of the Northeast Quarter of the Northeast Quarter of said Section 32 described as follows:

Commencing at the northeast corner of said Northeast Quarter of the Northeast Quarter; thence on an assumed bearing of South 89 degrees 45 minutes 03 seconds West along the north line of said Northeast Quarter of the Northeast Quarter, 147.60 feet; thence South 00 degrees 14 minutes 57 seconds West, 510.00 feet; thence South 89 degrees 45 minutes 03 seconds West, 1137.04 feet to the intersection of a line which is parallel and distant 166.00 feet southeasterly of the eastbound centerline of Interstate Highway No. 90 and the point of beginning of the parcel to be described; thence North 37 degrees 35 minutes 13 seconds East, along said line 443.97 feet; thence North 84 degrees 23 minutes 40 seconds East, 475.22 feet; thence North 00 degrees 14 minutes 57 seconds West, 55.00

## EXHIBIT A: 10<sup>TH</sup> STREET N.W.

(Formerly C.S.A.H. No. 35)

feet; thence South 89 degrees 45 minutes 03 seconds West, 144.38 feet; thence South 83 degrees 01 minutes 00 seconds West, 371.57 feet to the intersection of a line which is parallel and distant 100.00 feet southeasterly of the eastbound centerline of Interstate Highway No. 90; thence South 37 degrees 35 minutes 13 seconds West, along said line, 443.85 feet to the west line of said Northeast Quarter of the Northeast Quarter; thence South 00 degrees 31 minutes 31 seconds East, along said west line, 106.93 feet to the intersection of a line which is parallel and distant 166.00 feet southeasterly of the eastbound centerline of Interstate Highway No. 90; thence North 37 degrees 35 minutes 13 seconds East, along said line 64.63 feet to the point of beginning.

AND

That part of the North 50 feet of the Northeast Quarter of the Northeast Quarter of Section 32, Township 105 North, Range 14 West, Olmsted County, Minnesota, lying easterly of the following described line:

Commencing at the northeast corner of said Northeast Quarter of the Northeast Quarter; thence on an assumed bearing of South 89 degrees 45 minutes 03 seconds West along the north line of said Northeast Quarter of the Northeast Quarter, 147.60 feet; thence South 00 degrees 14 minutes 57 seconds West, 510.00 feet; thence South 89 degrees 45 minutes 03 seconds West, 1137.04 feet to the intersection of a line which is parallel and distant 166.00 feet southeasterly of the eastbound centerline of Interstate Highway No. 90; thence North 37 degrees 35 minutes 13 seconds East, along said line 443.97 feet; thence North 84 degrees 23 minutes 40 seconds East, 475.22 feet to the point of beginning of the line to be described; thence North 00 degrees 14 minutes 57 seconds West, 115.00 feet to the north line of said Northeast Quarter and said line there terminating.

AND

That part of the North 50 feet of the Northwest Quarter of Section 33, Township 105 North, Range 14 West, Olmsted County, Minnesota, lying west of the following described parcel:

That part of the Northwest Quarter and the Northeast Quarter of Section 33, Township 105 North, Range 14 West, Olmsted County, Minnesota, described as follows:  
Beginning at the northwest corner of the Northeast Quarter of said Section 33; thence North 89 degrees 33 minutes 20 seconds East, assumed bearing, along the north line of said Northeast Quarter, 331.43 feet to the east line of the West 20 acres of said Northeast Quarter; thence South 00 degrees 29 minutes 11 seconds East, along said east line, 1218.39 feet; thence South 89 degrees 30 minutes 49 seconds West, 53.50 feet; thence North 00 degrees 29 minutes 11 seconds West, 180.00 feet; thence North 16 degrees 48 minutes 52 seconds West, 772.02 feet; thence North 00 degrees 35 minutes 47 seconds West, 57.19 feet; thence North 37 degrees 15 minutes 15 seconds West, 100.87 feet; thence North 13 degrees 52 minutes 49 seconds West, 112.92 feet; thence North 00 degrees 17 minutes 40 seconds West, 50.00 feet to the north line of the Northwest Quarter of said Section 33;



**EXHIBIT A: 10<sup>TH</sup> STREET N.W.**

**(Formerly C.S.A.H. No. 35)**

thence North 89 degrees 42 minutes 20 seconds East, along the north line of said Northwest Quarter, 25.59 feet to the point of beginning.

AND

That part of the North 50 feet of the West two (W. 2) Acres of the East one-hundred Forty (E. 140) Acres of the Northeast Quarter of Section 33, Township 105 North, Range 14 West, Olmsted County, Minnesota, except land already within the City.

In all, containing 11.92 acres, more or less.

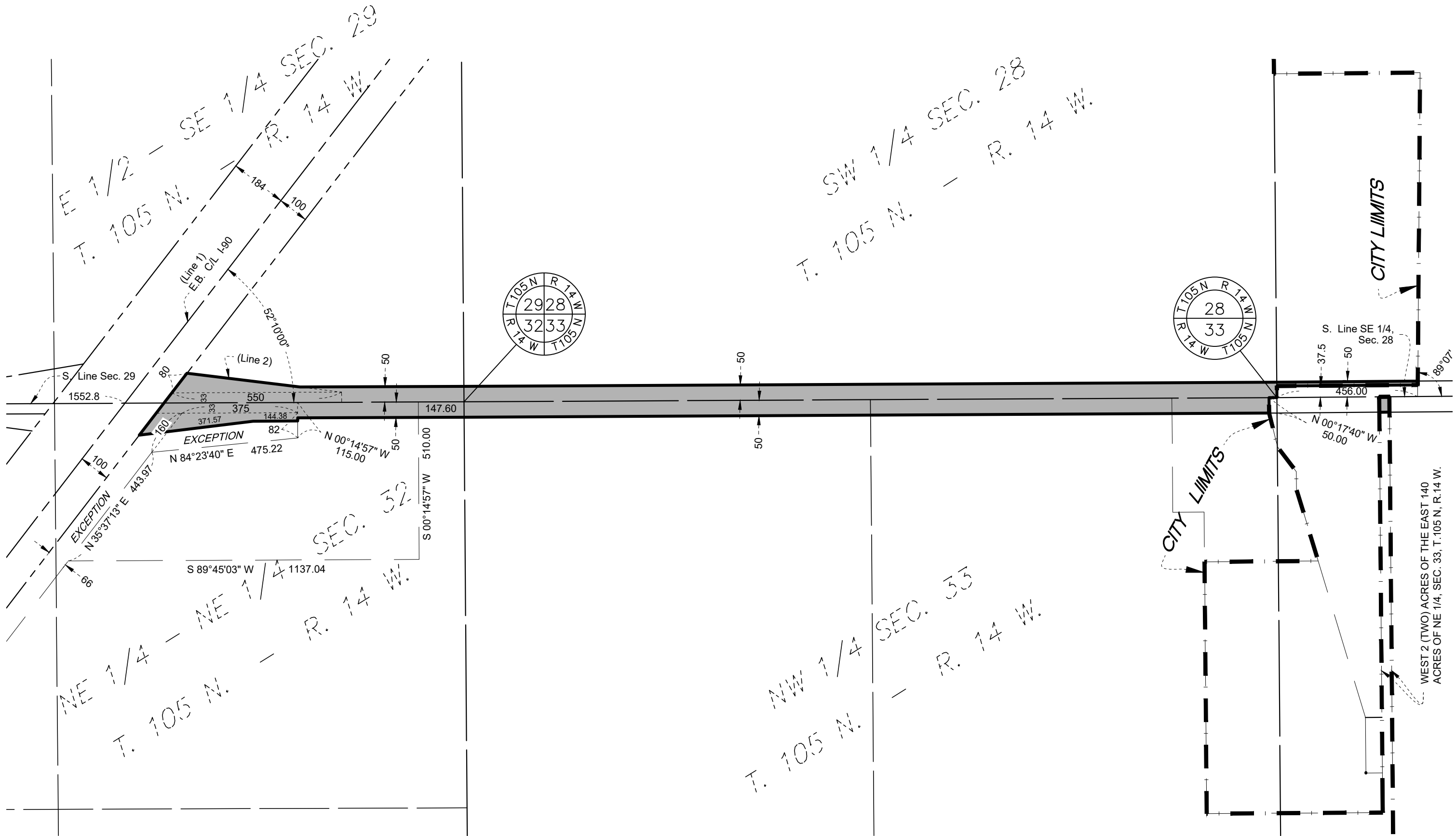

SEH Project	STEWV 159361	Revision Issue Description	Date
Drawn By	MJH		
Surveyed By	MJH		
Checked By	MJH		

**ANNEXATION EXHIBIT FOR:**  
**10th Street N.W.**  
 (Formerly C.S.A.H. No. 35)  
**STEWARTVILLE, MINNESOTA**



I HEREBY CERTIFY THAT THIS SURVEY WAS PREPARED BY ME OR UNDER MY DIRECT SUPERVISION AND THAT I AM A DULY LICENSED LAND SURVEYOR UNDER THE LAWS OF THE STATE OF MINNESOTA.

*Mark J. Haselius*  
 MARK J. HASELIUS

DATE DECEMBER 01, 2022 LICENSE NO. 47034

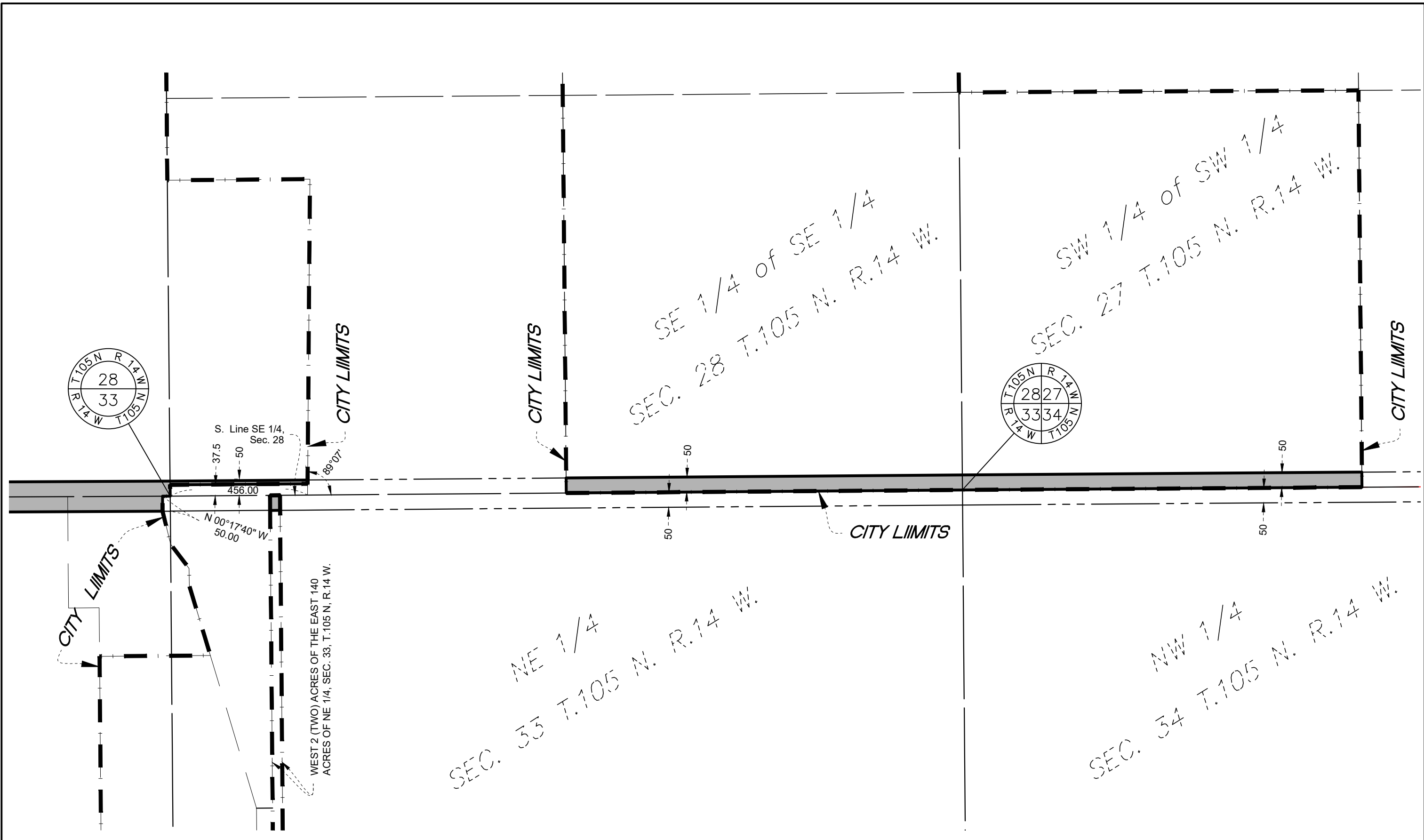

SEH Project	STEVV 159361	Revision Issue	
Drawn By	MJH	Description	
Surveyed By	MJH		
Checked By	MJH		
		Date	

**ANNEXATION EXHIBIT FOR:**  
**10th Street N.W.**  
 (Formerly C.S.A.H. No. 35)  
**STEWARTVILLE, MINNESOTA**



I HEREBY CERTIFY THAT THIS SURVEY WAS PREPARED BY ME OR UNDER MY DIRECT SUPERVISION AND THAT I AM A DULY LICENSED LAND SURVEYOR UNDER THE LAWS OF THE STATE OF MINNESOTA.

*Mark J. Haselius*  
 MARK J. HASELIUS

DATE DECEMBER 01, 2022 LICENSE NO. 47034

## ORDERLY ANNEXATION AGREEMENT

### EXHIBIT B

The following property contained in High Forest Township, Township 105 North, Range 14 West, Olmsted County, Minnesota:

That part of Section 21, lying southeast of Interstate 90;

That part of Section 22, lying southeast of Interstate 90;

The Southwest Quarter of Section 23, and that part of the Northwest Quarter of Section 23, lying southeast of Interstate 90, and the West Half of the Northeast Quarter of Section 23, and all of the Southeast Quarter of Section 23;

That part of the East Half of Section 29, lying southeast of Interstate 90;

That part of Section 28, lying southeast of Interstate 90;

Section 27;

The West Half of Section 26, and the West Half of the Southeast Quarter of Section 26, and all of the Northeast Quarter of Section 26;

That part of Section 32, lying southeast of Interstate 90;

Section 33;

Section 34;

The West Half of Section 35, and the West Half of the East Half of Section 35;

And the following property contained in High Forest Township, Township 104 North, Range 14 West, Olmsted County, Minnesota:

That part of the North Half of Section 5, lying southeast of Interstate 90;

The North Half of Section 4;





The North Half of Section 3;



The West Half of Section 2, and the Northeast Quarter of Section 2, and the North Half of the Southeast Quarter of Section 2;

The West Half of the Northwest Quarter of Section 1, and the Northwest Quarter of the Southwest Quarter of Section 1.

This Orderly Annexation Agreement shall apply to all lands described above that are not currently within present city limits.



 Orderly Annexation Agreement Limits  
 Owners outside City Limits  
 City of Stewartville  
 Sections

0 0.125 0.25 0.5 Miles

